

---

---

# CableGlider® FO Cable Puller

---

---

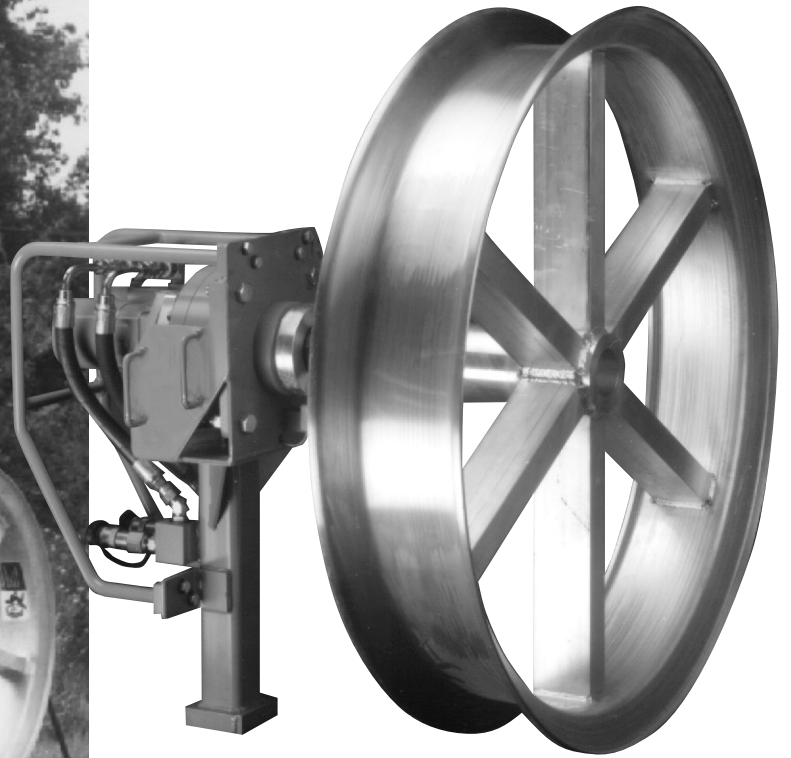

**ISO 9001:2008**  
**CERTIFIED**

# Important Safety Notice

---

Read and understand all procedure and safety instructions before using a Condux Fiber Optic Cable Puller. Observe all safety information on this page and note specific safety requirements as explained by procedures called out in this manual. Failure to follow these instructions could result in serious personal injury or death.

## ADVERTENCIA:

Favor de leer y comprender todas las instrucciones de operación y seguridad antes de usar la máquina. Si Ud. no comprende las instrucciones favor de consultarle a su jefe.

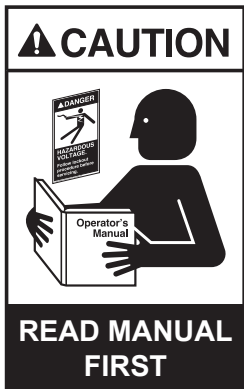

**Save this user's guide for future reference.**



If you have questions on:

**SAFETY - OPERATIONS - APPLICATIONS**

CALL 1-800-533-2077

# Table of Contents

---

<b>1</b>	General Information	4
<b>2</b>	Technical Specifications	4
	a. Hydraulics	4
	b. Power Requirements	4
	c. Digital Chart Recorder	4
	d. Factory Presets	4
	e. Maximum Pulling Capacities	4
<b>3</b>	Safe Operating Practices	5
	a. Work Area Safety	5
	b. Hydraulic Devices	5
	c. Electric Devices	5
<b>4</b>	Unpacking the Fiber Optic Cable Puller	6
	a. Puller Components	6
<b>5</b>	Set up the Puller	7
	a. Mount the Puller	7
	b. Connect the Hydraulic Systems	7
	c. Position the Foot Control Valve Assembly	8
	d. Attach the Capstan	9
<b>6</b>	Set Up the Electronic Control System	9
	a. Switch Configuration	9
	b. Connect the Electronics	10
	c. Setting Up the Electronic Control Box	11
	d. Digital Chart Recorder Set Up	11
	e. Data Download Instructions	13
<b>7</b>	Finish Puller Setup	14
<b>8</b>	Final Inspection	14
<b>9</b>	Puller Operating Instructions	15
<b>10</b>	Tear Down Procedures	16
	a. Remove Hydraulic Power Supply	16
	b. Disconnect Electronics	16
	c. Remove Capstan from Puller	16
<b>11</b>	Puller Calibration	17
	a. Verify the Puller's Calibration Settings	17
	b. Hydraulic Pressure Relief Valve Calibration	17
	c. Electronic Tension Control System Calibration	19
<b>12</b>	Troubleshooting Guide	20
	a. Puller	20
	b. Electronic Control Box	21
	c. Foot control valve	22
<b>13</b>	Replacement Parts & Accessories	23
<b>14</b>	Warranty Information	24
	a. Factory Assistance	24
	b. Puller Calibration	24
	c. Limited Warranty	24

# General Information

## 1.

The Condux Fiber Optic Cable Puller is a hydraulic pulling machine designed for fiber optic cable placement. It offers bi-directional pulling and load-sensing capabilities. The system uses a hydraulic motor and capstan with an electronic tension control system.

The tension control system uses an electronic load cell to measure the actual torque at the puller's motor. Combining this torque value with the capstan's diameter ensures accurate tension monitoring. The system's design gives the operator complete control over the equipment. It can be set to a maximum tension limit that will stop the puller and give both audible and visual alarms if the tension limit is exceeded during the pull.

A digital chart recorder continuously records the pulling tensions during operation. The power pack or the vehicle's 12 Volt DC power point energizes the electronic tension control system.

The puller comes standard with a variable speed foot control and hoses to the puller motor, an adjustable flow control valve for adjusting maximum pulling speed, and a manually adjustable pressure relief valve for adjusting the maximum pressure supplied to the hydraulic motor.

## Technical Specifications

## 2.

### A. HYDRAULICS

- Open center system
- Pressure: 2000-2500 psi (137-172 bar)
- Flow: 6-10 gpm (22.7-37.9 lpm)
- Relief valve setting: 2250 psi (155 bar)
- Reservoir capacity: 12 gallons (45.5 l)
- Filtration: 10 micron nominal
- Hydraulic Fluid: Petroleum-based, anti-wear properties, viscosity's over 140
- Horsepower: Min. 8 hp (5.97 kW)

### B. POWER REQUIREMENTS

- 12 volts direct current (DC) for electronic control box

### C. DIGITAL CHART RECORDER

- Variable Sample Rate
- 256MB Compact Flash Card
- Download directly to computer via USB connection

### D. FACTORY PRESETS

- Relief Valve:
  - 1,783 lbs. (7,930 N) line tension on the 12" (305 mm) diameter capstan
  - 700 lbs. (3,113 N) line tension on the 30" (762 mm) diameter capstan
  - 428 lbs. (1,903 N) line tension on the 42" (1,067 mm) diameter capstan
- Electronic Control Box: 650 lbs. (2,891 N) line tension, any capstan

### E. MAXIMUM PULLING CAPACITIES

- 2,000 lbs. (8,896 N) line tension on the 12" (305 mm) diameter capstan
- 1,000 lbs. (4,448 N) line tension on the 30" (762 mm) diameter capstan
- 600 lbs. (2,669 N) line tension on the 42" (1,067 mm) diameter capstan

# Safe Operating Practices

## 3.

Read and understand all procedure and safety instructions before using the Condux Fiber Optic Cable Puller. Observe all safety information on this page and note specific safety requirements as explained by procedures called out in this manual. Failure to follow these instructions could result in serious personal injury, property damage or death.

### A. WORK AREA SAFETY

1. Wear personal protective equipment: hard hat, safety glasses, safety shoes, and leather work gloves.
2. The safe operation of this equipment requires that the operator's be on stable footing.
3. Stay clear of cables or lines under tension. Do not stand directly behind the puller.
4. Stay clear of rotating equipment.
5. Use the puller only for its intended purpose. Do not hoist people or equipment, and do not wind up pulling lines with the capstan.
6. Start all pulls slowly and increase speed as the puller stabilizes.
7. Be aware of the location of all underground utilities in your work area.

### B. HYDRAULIC DEVICES

Escaping fluids under pressure can penetrate the skin and cause serious personal injury. Observe the following precautions to avoid hydraulic hazards:

1. Tighten all connections before applying pressure. Relieve pressure when connecting or disconnecting hoses and when servicing the unit.
2. Check for leaks with a piece of cardboard. Do not use your hands!
3. Do not exceed working pressure of hydraulic hoses.
4. Visually inspect hoses regularly and replace if damaged.

### C. ELECTRIC DEVICES

The electronic control box is an electrical device. Electric shock hazards exist that could result in severe personal injury or death. Observe the following precautions to avoid electrical hazards:

1. Do not operate in or near water. This includes setting the electronic control box on a wet surface or exposing it to rain.
2. Do not remove cover of electronic control box. There are no user-serviceable parts inside. Refer servicing to qualified service personnel.
3. The electronic control box power switch should be in the off position before connecting or disconnecting any cords.
4. Do not connect the electronic control box directly to a vehicle's battery; use the power pack, the vehicle's 12 Volt DC power point, or the vehicle's lighter socket.

# *Unpacking the Fiber Optic Cable Puller*

---

## 4.

### **A. PULLER COMPONENTS**

#### 1. Fiber Optic Cable Puller Package 1

Part Number: **08690001**

- Hydraulic puller mounted on a 2½ inch (64 mm) square tube
- Foot control valve assembly
- Hydraulic hoses from puller to foot control valve assembly (10 foot)
- Hydraulic hoses from foot control valve assembly to power supply (20 foot)
- Owner's manual
- Shipping crate

#### 2. Fiber Optic Cable Puller Package 3

Part Number: **08690055**

All Items in Package 1 Plus:

- Electronic load cell mounted on puller
- Electronic control box with digital chart recorder
- Electronic cord from control box to puller
- Electronic cord from control box to foot control valve assembly
- Power cord, vehicle's power point to control box

**!NOTE:** If any parts are missing, please contact your Condux representative or call Condux International at 1-800-533-2077.

# Set up the Puller

This manual contains setup and operating instructions for the Condux Fiber Optic Cable Puller with electronic control box, if equipped. Where operations differ for the other available packages, the instructions specify those differences.

5.

## A. MOUNT THE PULLER

1. The Fiber Optic Cable Puller has a 2½ x 2½ inch (64 x 64 mm) square mounting post. A female receiver, such as the receivers listed in appendix 13.F and 13.G, is recommended. Use grade 5 or grade 8 capscrews to attach these mounts. Materials used for constructing your own mount should have a minimum wall thickness of ¼ inch (6.25 mm). All welds should be continuous, and gussets should be used where possible.

**!CAUTION:** Lift the Fiber Optic Cable Puller only with proper equipment or sufficient manpower. Improper lifting techniques may result in personal injury or property damage.



## B. CONNECT THE HYDRAULIC SYSTEMS

The Fiber Optic Cable Puller's hydraulic system uses quick-connect couplings. Keep all connections clean to avoid contamination and possible system failure. Follow these steps to connect the hydraulic components:

1. Connect the hydraulic supply hoses to the foot control valve assembly. **Ensure the pressure hose from the power source goes to the inlet of the foot control valve** (labeled PRESSURE on the foot control valve assembly, figure 1).
2. Connect the hoses from the foot control valve assembly to the puller (figure 2). The supply hose assembly has four identical male couplings and can be attached between the puller and foot control valve assembly in any orientation.

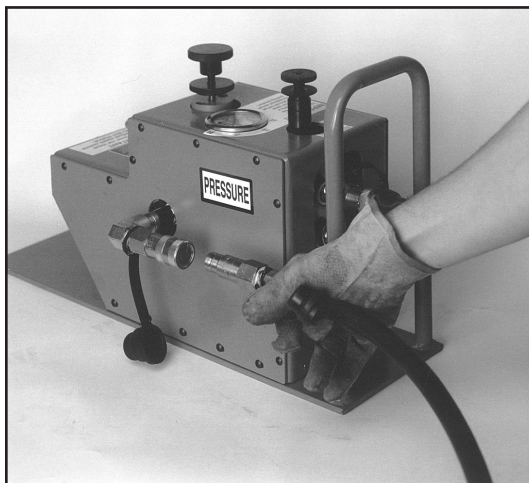

Figure 1. Power Supply Connections

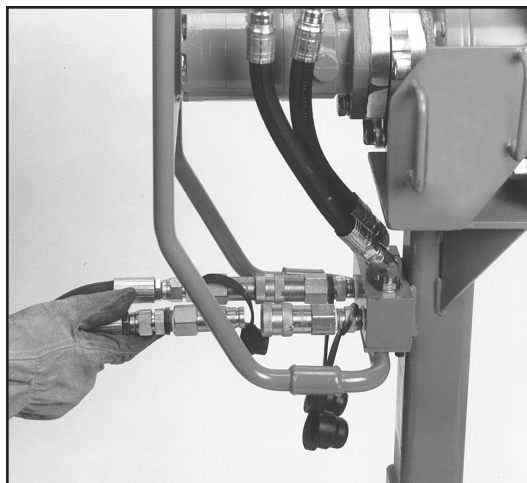

Figure 2. Foot Control Connections

**!NOTE:** Switching the quick-connect couplings on one end of hose assembly between the puller and the foot control valve assembly will reverse the direction of capstan rotation.

3. Start the hydraulic power source and check all connections for leaks with a piece of cardboard. Run the puller in both directions to ensure proper operation.





**!WARNING:** Escaping fluids under pressure can penetrate the skin and cause serious personal injury. Observe the following precautions to avoid hydraulic hazards:

- Tighten all connections before applying pressure. Relieve pressure before connecting or disconnecting hoses.
- Check for leaks with a piece of cardboard. Do not use hands!
- Do not exceed working pressure of hydraulic hoses. Visually inspect hoses regularly and replace if damaged.

5. Run the puller for approximately 1 minute to remove any trapped air and then stop the hydraulic power source.

**!CAUTION:** Use a minimum 10 micron nominal filter for proper filtration of the hydraulic system. Equipment failure could result from improper filtration.

### C. POSITION THE FOOT CONTROL VALVE ASSEMBLY

The foot control valve assembly controls the speed and direction of rotation of the capstan. The further the foot pedal is pushed down, the faster the puller turns. To temporarily reverse the capstan, the foot pedal can be lifted up.

**!NOTE:** Cable must be pulled only while pushing *down* on the foot pedal. To pull cable with the capstan rotating the opposite direction, reverse the quick-connect couplings of the hydraulic hoses on the puller (see previous section).

1. The foot control valve assembly is fitted with an adjustable speed control stop. The speed control stop relieves operator foot fatigue by limiting the downward travel of the foot pedal. **Do not force the pedal if it does not move.** Adjust the speed control knob counterclockwise to increase speed, clockwise to decrease speed. The operator should now feel the pedal move freely.
2. Position the foot control valve at least 3 to 4 feet (0.9 to 1.2 m) from the capstan's feed-off side (figure 3). Position the foot control in the best possible location for safety and proper operation. Multiple operators may be required for safety or operational requirements.

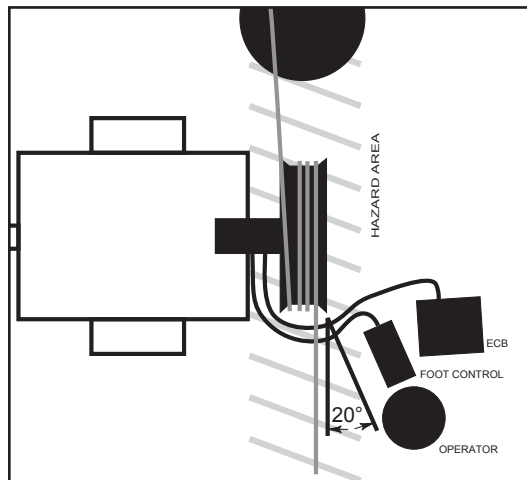

**Figure 3. Foot Control Valve Assembly Placement**

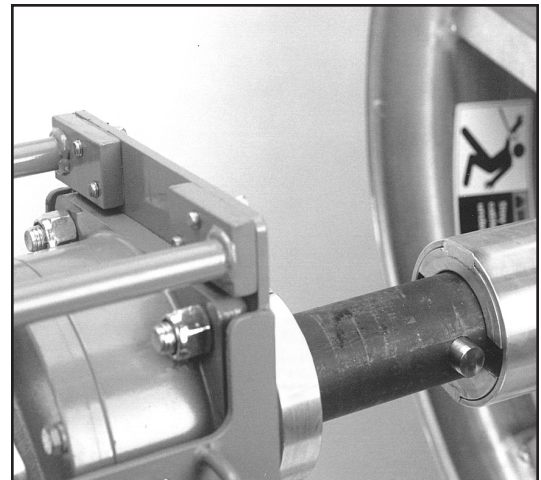

**Figure 4. Capstan Assembly**

3. The manually adjustable pressure relief valve allows a secondary method of controlling the maximum pulling tension. The relief valve is factory set to release the hydraulic pressure at approximately 700 pounds (3113 N) of pulling tension while using the Condux 30 inch (762 mm) diameter capstan. If required, adjust the relief valve to a



different load setting. See section 11.B for details. For proper operation, the relief valve must be set at a tension limit greater than the electronic tension limit.

#### D. ATTACH THE CAPSTAN

1. Attach the 30 inch (762 mm) diameter capstan to the puller's shaft (figure 4) by aligning the capstan's slots with the shaft's pins. Push the capstan onto the shaft until it stops, then rotate clockwise until it stops. Pull outward to lock the capstan into position. **Make sure the shaft locking pins are visible through the holes in the capstan hub.**

**!NOTE:** If using a capstan with a diameter other than 30 inches (762 mm), the hydraulic relief valve must be recalibrated (section 11).

## Set Up the Electronic Control System

If the puller is not equipped with the electronic tension control system, go to section 7.



#### A. SWITCH CONFIGURATION

Following is a brief explanation of each of the switches for the Condux Fiber Optic Cable Puller Electronic Control System. Detailed instructions for using the equipment follows these explanations.

1. Electronic Control Box Panel Switches (Figure 5)

**Power:** Turns control box **ON** or **OFF**.

**Set Tension Limit:** Sets the limit where the control box will stop the puller. Press and hold **UP** or **DN** button to set the desired value.

**Tension Limit Control:** Determines if the puller will stop rotating when the preset tension limit is reached. Switch to **ON** to activate the hydraulic bypass valve and stop the puller when the tension limit is reached. Switch to **OFF** to disable the hydraulic bypass valve.

**Zero Display:** Set the display to zero before beginning. Press "Prog" button to zero display.

**Capstan Selection Switch:** Sets the control box to display the proper pulling forces depending on the size capstan used. Turn switch to set desired capstan diameter. The meter automatically calibrates the displayed force to the selected capstan size.

**Limit Reset:** Resets the control box and puller after the preset tension limit has been exceeded. Press button to reset hydraulic bypass valve and audible alarm. This can be done only when the tension is below the preset limit.

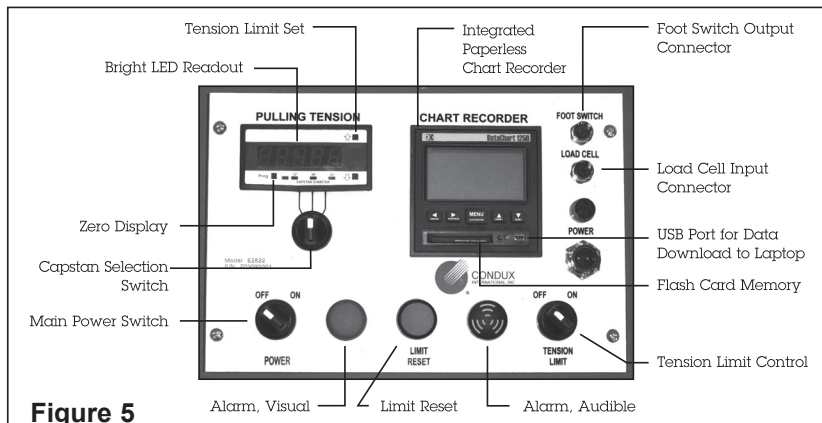

Figure 5

## B. CONNECT THE ELECTRONICS

**!DANGER:** The electronic control box is an electrical device. Electric shock hazards exist that could result in severe personal injury or death. Observe the following precautions:

- Do not expose electronic control box to water.
- Do not remove cover of electronic control box (no user-serviceable parts inside). Refer servicing to qualified personnel.
- The electronic control box power switch should be in the off position before connecting or disconnecting any cords.



1. Connect the male end of the 5-pin sensing cord to the female connector on the Electronic Control Box labeled "LOAD CELL". (see Figure 6) Connect the female end of the cord to the male receptacle located near the load cell. (See Figure 7). Before making these connections, ensure the receptacles are free of dirt and moisture. Do not modify this cord's length.

Tighten the connector collars over the threaded portion of the receptacles. This prevents the cord from coming loose during operation. This cord is necessary to measure the tensions sensed by the load cell.

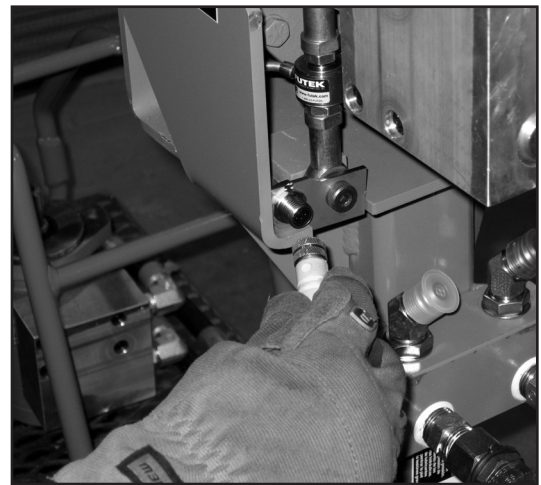

Figure 6. Load Cell Connection on ECB

Figure 7. Load Cell Connection on Puller

2. Connect the male end of the 3-pin footswitch control cord to the female connector on the Electronic Control Box labeled "FOOTSWITCH" (see Figure 8). Connect the female end of the control cord to the male receptacle located on the foot control valve assembly (see Figure 9). **NOTE:** If the connector on the foot switch is 2-pin, use the patch cord (08675926) included in the upgrade kit (08675920) to convert to the required connection. Before making these connections, ensure the receptacles are free of dirt and moisture. **Do not modify this cord's length.**

Tighten the connector collars over the threaded portion of the receptacles. This prevents the cord from coming loose during operation. This cord is necessary to measure the tensions sensed by the load cell.



Figure 8. Foot Switch Connection on ECB

Figure 9. Foot Switch Connection

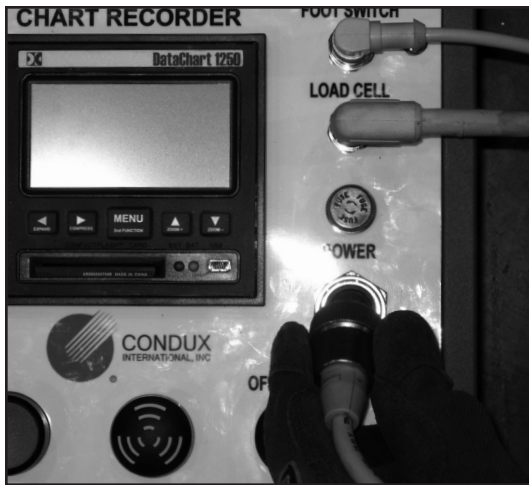

Figure 10. ECB Power Connection

3. The 7/8" 2-pin connector on the front panel of the electronic control box supplies electrical power to the electronic control box. (see Figure 10) This power can come from the power pack, a vehicles power point, or a lighter socket. The electronic control box requires 12 Volt DC power for proper operation.
4. Connect the power cord to the 2-pin connector labeled "POWER". Before making these connections, ensure the receptacle is free of dirt and moisture. Tighten the connector collar over the threaded portion of the receptacle. This will prevent the cord from coming loose during operation. Connect the other end of the power cord to a 12 Volt DC power source.

### C. SETTING UP THE ELECTRONIC CONTROL BOX

The Condux Fiber Optic Tensiometer has been designed to give the operator continuous tension information and automatic shut-off control during a pull. The Electronic Control Box features an LED Display, Digital Graph Display, 256MB Flash Card, and a 3 capstan selection switch. A programmable overload set point with both visual and audible alarms is designed to disengage the cable puller should an overload occur. Navigator software is provided so pulling information can be downloaded onto any computer running Windows 2000® or XP®.

**!DANGER:** The Main Power switch supplies power to the indicator and chart recorder. When a power supply is connected to the electronic control box, portions of it are energized. Follow all electrical equipment precautions.

**!NOTE:** Always disconnect the power cord when the electronic control box is not in use. When the power cord is connected to the electronic control box, it energizes portions of the control box. If the power cord is left attached when the control box is not in use, it will drain the power supply.

1. Turn the power switch on the Electronic Control Box to the "ON" position (See Figure 5). Be sure that the sensor cords are properly connected before turning on power.
2. **Select the capstan size.** Turn the capstan selection switch so the appropriate channel is lit on the Meter. In order to get accurate results, the correct capstan size must be selected. The electronic control box is programmed to accurately return pull tension for Condux 12", 30", and 42" fiber optic capstans.
3. **Set the cable Tension Limit.** Press the "Prog" Button and ▼ button simultaneously. (See Figure 5) SP-1 will appear on the on the LED Screen. The screen will alternate between SP-1 and the current tension limit. Press the ▲ and ▼ buttons to increase or decrease the tension limit. Once the desired tension limit is set, press "Prog" to save the set point.
4. **Zero the display.** Press the "Prog" button.
5. **Alarms:** When Tension Limiter switch is in the "OFF" position the audio alarm will sound and the light will come on when the tension limit is reached. When the Tension Limiter switch is in the "ON" position the puller will also stop pulling when the tension limit is reached (See Figure 5)

**!CAUTION:** Damage to cable may result from excessive pulling forces. Use precautions to safeguard against overload conditions.





## D. DIGITAL CHART RECORDER SET UP

The Digital Chart Recorder is the next generation Solid State Data Recorder/Panel Recorder. This instrument has all the capability of a traditional paper recorder – variable chart speeds, the ability to review historic data, see trends and more. All pull data is stored on the 256MB Compact Flash Card that comes with the unit.

1. Name File Press “MENU” button to enter the Menu screen. Use ▲ and ▼ arrows to scroll to RECORD MODE and press menu. Next, scroll to “NAME FILE” and press MENU. Use the ▲ and ▼ buttons to scroll through letters and the ◀ and ▶ buttons to move spaces. (See Figures 11-14). Once the name is set press “MENU” button to go back to Record Mode. From Record Mode, ◀ or ▶ will return to Menu screen. Pressing ◀ or ▶ again will return to charting screen.
2. Set to Record Mode: If you are already in the Record Mode screen, use the ▲ and ▼ buttons to scroll to “ON”. If you are starting from the charting screen, press “MENU” and scroll to Record Mode. Press “MENU” again to enter Record Mode, and scroll to ON. Push the “MENU” button to put a check mark next to “ON”. Your unit is now ready to record. The red light on the Chart Recorder panel should turn on when unit is recording. Press the ◀ or ▶ to return to the Menu screen. Press ◀ or ▶ again to get back to the charting screen.

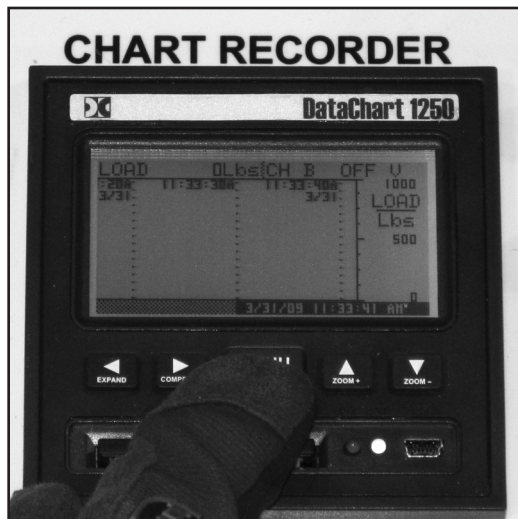

Figure 11. Menu Button Activation



Figure 12. Record Mode



Figure 13. Name File



Figure 14. Enter Pull Name

**NOTE:** The recorder is time based, meaning if the recorder is not switched to "OFF" between pulls, the data recorder will report long time periods of zeros.

3. Set Sample Rate: Press the "MENU" button and the menu screen will appear. Using the ▲ and ▼ button, scroll to SAMPLE RATE. Press the "MENU" button and your list of sample rate options will appear. Select the sample rate you desire and press "MENU" to select. Press the ◀ or ▶ buttons twice to get back to the charting screen.

**NOTE:** See Data Chart 1250 Manual on included CD for more information.

## **E. DATA DOWNLOAD INSTRUCTIONS**

The Running Line Tensiometers come with accessories for downloading your pull data: Navigation software, 256MB Flash Card, card reader and USB cable.

### **Downloading data to your computer via USB Cord**

1. Connect Recorder to PC or laptop with supplied USB cord
2. Turn ECB on \*and make sure that Record Mode has been turned to OFF.
3. Open Navigator software on PC
4. In Navigator software select "FILE" and "USE RECORDER"
5. Select Open to pull in pulling data from recorder.
6. Select your file and click "OK"

### **Downloading data to your computer via Flash Card**

1. Plug card reader into the PC's USB connection.
2. \*Make sure that Record Mode has been turned to OFF. Remove Flash Card from ECB recorder and install into the card reader.
3. In Navigator software select open
4. A file screen will appear. Locate the removable drive and select pull data file.
5. Double click pull data file to load into Navigator software.

*See Navigator Software manual for additional information.*

## Finish Puller Setup

7.

a. Move the puller into its final position. The pull line will wrap best on the capstan if the capstan is angled about  $10^\circ$  away from the pull line (figure 18). This will allow the line to walk down the side of the capstan and push the previous wraps to the side.

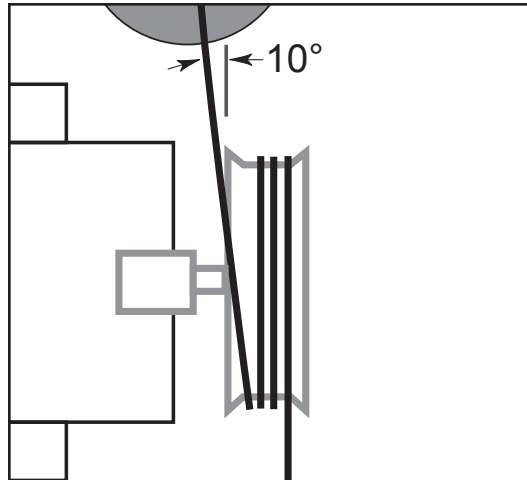

Figure 18. Puller Positioning

b. Place four or more side-by-side wraps of the pull line around the capstan in the direction of rotation. Do not wrap more than one layer of pull line on the capstan.

c. Start the hydraulic power source.

## Final Inspection

8.

**!WARNING:** Before placing the puller into operation, always perform a final inspection of it and all components used.

a. The foot control pedal has full range of motion and is in the neutral position.

b. The electronic control box POWER switch is **ON**.

c. The tension limit is set correctly.

d. The TENSION LIMIT CONTROL is **ON**, if overload control is required.

f. The chart recorder's Record Mode has been switch to **ON**.

g. All safety requirements are met and all people are aware that the unit will be set in motion.



# Puller Operating Instructions

- a. Slowly press the foot control pedal. Remove any slack or excess pull line before increasing the puller's speed. Attend the line coming off the capstan to avoid any tangles, and keep some tension on the line so that the capstan grips the pull line.

Never wrap the line around your hand, arm, foot, or leg, and always be prepared to release the line. Stand at least 3 to 4 feet (0.9 to 1.2 m) away and at a 20 degree angle from the capstan. Wear gloves to avoid rope burns and abrasions.

**!NOTE:** To avoid damage to the fiber optic cable, always start the pull slowly, and increase speed as the puller and cable stabilize.

**!CAUTION:** Stand to side of pull line to prevent injury in case it breaks. Always wear protective equipment: hard hat, safety glasses, safety shoes, and work gloves.

**!WARNING:** Stay clear of the rotating capstan. Severe personal injury or death could result from entanglement with it or the pull line. Follow these safety precautions:

- Do not wrap the pull line around a hand, arm, foot, or leg.
- Always be ready to release the pull line.

- b. When the TENSION LIMIT CONTROL is **ON**, the puller will stop pulling if the cable tension exceeds the programmed limit of the electronic control box. Release the foot pedal and the cable or pull-line tension will slowly release.

Slowly reverse the puller to release cable or pull-line tension by lifting up on the foot pedal. Many pull lines build up tension from stretching. Never approach or service a pull line under tension. Always release tension before proceeding.

- c. When the electronically programmed tension overload limit is set higher than the adjustable relief valve, the puller will stop when the relief valve setting is reached. Increase the relief valve setting by turning the manifold knob clockwise. To decrease the setting, turn the valve counterclockwise. See section 11.B for details on adjusting the relief valve manifold.

- d. If the pulling operation exceeds the electronic tension limit or relief valve setting, correct the cause for high tension.

9.



# Tear Down Procedures

# 10.

## A. REMOVE HYDRAULIC POWER SUPPLY

1. Stop the puller by releasing the foot pedal to its neutral position.
2. Shut off the hydraulic power supply.
3. Push the foot pedal down and lift up at least 3 times to relieve the hydraulic system's back pressure.

**! WARNING**

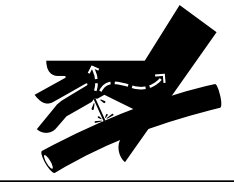

**!WARNING: Escaping fluids under pressure can penetrate the skin and cause serious personal injury. Release pressure before disconnecting hoses.**

4. Disconnect all hydraulic supply hoses. Cap all hose ends and connectors to guard against contamination.

## B. DISCONNECT ELECTRONICS

**!DANGER: The electronic control box is an electrical device. Electric shock hazards exist that could result in severe personal injury or death. Follow all electrical safety precautions in this manual.**

1. Turn off the electronic control box.
2. Disconnect the power cord between the electronic control box and the 12 Volt DC power supply.
3. Unplug the sensing cord from the puller and the control cord from the foot control valve assembly.

**! DANGER**



## C. REMOVE CAPSTAN FROM PULLER

1. Push inward on the capstan and rotate it counterclockwise (figure 19).
2. Align the capstan's slots with the shaft's pins and pull off.

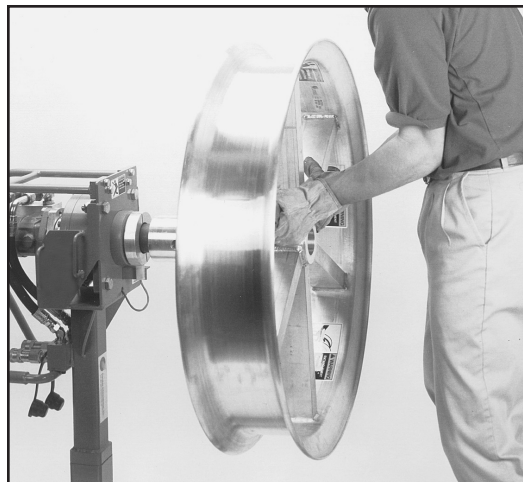

**Figure 19. Capstan Disassembly**

# Puller Calibration

When using the electronic control system, the Condux Fiber Optic Cable Puller does not need to be calibrated on a regular basis; however, the calibration should be checked periodically (at least yearly) to ensure that the calibration has not changed. If the calibration procedures specified below are not possible at the operator's location, we recommend returning the unit to Condux International for calibration by the factory. See section 15 for details on returning the puller to Condux International for calibration.

# 11.

## A. VERIFY THE PULLER'S CALIBRATION SETTINGS

1. Set up the puller as if cable were to be pulled, including installation of the capstan (figure 21).
2. Place a pull line around the capstan. The pull strength of the pull line must exceed the 2,000 pound maximum capacity of the Fiber Optic Cable Puller.

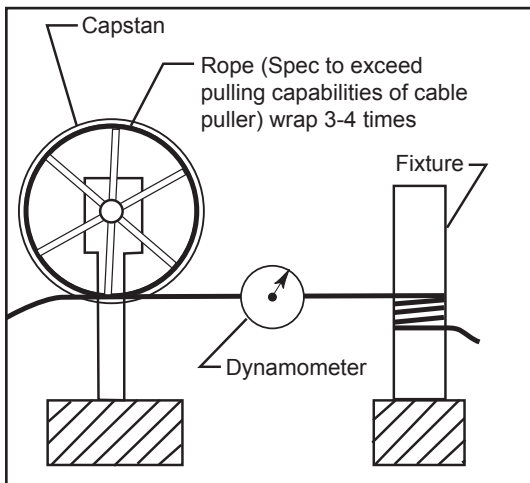

Figure 21. Calibration Verification Setup

Figure 22. Pressure Relief Valve

4. Set the electronic control box tension limit according to the load rating on the capstan.
5. Slowly apply pressure to the puller to tighten the pull line. Continue to pull until the relief valve opens. The value shown on the dynamometer will be the force at which the pressure relief valve is set for this hydraulic fluid temperature (see next page).
6. Release pressure to the puller.
7. Set the electronic control box tension limit to the desired tension to be verified.
8. Slowly apply pressure to the puller to tighten the pull line. Continue to pull until the electronic control system stops the puller and the alarm sounds. The value shown on the dynamometer should match the tension limit set on the electronic control box.

## B. HYDRAULIC PRESSURE RELIEF VALVE CALIBRATION

The hydraulic pressure relief valve on the Fiber Optic Cable Puller is calibrated to the following loads.

- Relief Valve: 1,783 lbs. (7,930 N) line tension on the 12" (305 mm) diameter capstan  
700 lbs. (3,113 N) line tension on the 30" (762 mm) diameter capstan  
428 lbs. (1,903 N) line tension on the 42" (1,067 mm) diameter capstan

If a different load is required, the relief valve can be adjusted with the following procedure. **Do not execute this procedure to verify the calibration (see previous section).**

**!CAUTION: Use the relief valve pressure only as a backup to the electronic tension control system or other load limiting means. Damage to the cable being installed may result.**

1. Set up the puller as if cable were to be pulled, including installation of the capstan (figure 21).
2. Place a pull line around the capstan. The pull strength of the pull line must exceed the 2,000 pound maximum capacity of the Fiber Optic Cable Puller.
3. Attach the pull line to a load indicator such as a Dillion dynamometer (section 14).
4. Release the lock nut on the relief valve (figure 22). Turn the relief valve stem counter-clockwise to adjust the valve down to zero pressure.
5. Slowly apply pressure to the puller to tighten the pull line. Continue to pull until the relief valve opens. The value shown on the dynamometer must be below the desired maximum load.
6. Release pressure to the puller. Turn the relief valve stem clockwise to increase the pressure setting (figure 22).
7. Slowly apply pressure to the puller to tighten the pull line. Continue to pull until the relief valve opens. The value shown on the dynamometer is the maximum load that the puller can pull. Repeat steps 6 and 7 until the desired maximum load is obtained.
8. When the desired maximum load is obtained, tighten the lock nut on the relief valve.
9. Verify the relief valve setting by slowly applying pressure until the relief valve opens. Check the value on the dynamometer and adjust the relief valve if necessary.

**!CAUTION: Use the relief valve pressure only as a backup to the electronic tension control system or other load limiting means. Damage to the cable being installed may result.**

**!NOTE:** Measuring the hydraulic pressure to the puller is not an accurate means for determining the pulling tensions. Component age and oil temperature affect hydraulic motor efficiency and torque output. The following chart shows the different approximate pulling tensions at different oil temperatures with a 30 inch (762 mm) diameter Condux capstan. **Use this chart as a comparative reference only and do not consider it to be the actual pulling tensions.**

Load (30" Capstan)		Oil Temperature											
		42° F		6° C		106° F		41° C		160° F		71° C	
		Pressure		Pressure		Pressure		Pressure		Pressure		Pressure	
lbs.	kN	psi	bar	psi	bar	psi	bar	psi	bar	psi	bar	psi	bar
150	0.67	750	51.7	480	33.1	500	34.5						
200	0.89	800	55.2	580	40.0	550	37.9						
300	1.33	975	67.2	800	55.2	725	50.0						
400	1.78	1150	79.3	1000	68.9	925	63.8						
500	2.22	1375	94.8	1200	82.7	1125	77.6						
600	2.67	1550	106.9	1400	96.5	1325	91.4						
700	3.11	1700	117.2	1600	110.3	1825	125.8						
800	3.56	1900	131.0	1800	124.1								
900	4.00	2050	141.3										

### **C. ELECTRONIC TENSION CONTROL SYSTEM CALIBRATION**

The electronic tension control system automatically calibrates itself to the 12", 30" and 42" Condux capstans simply by turning the Capstan Selection Switch. **To verify calibration see section 11.A.**

**!NOTE:** If the puller calibration is in question, contact the factory for calibration information at 1-800-533-2077.

# Troubleshooting Guide

## 12.

### A. PULLER

PROBLEM:	SOLUTION:
	<ul style="list-style-type: none"> <li>Reverse the connections on one end of the hose assembly between the foot control valve assembly and the puller (see section 5.B.2)</li> </ul>
<p>Capstan does not rotate in the required direction when the foot pedal is depressed. Foot control pedal will not depress fully.</p>	<ul style="list-style-type: none"> <li>The adjustable flow control knob on foot control could be limiting movement. Turn flow control knob counterclockwise until full movement is achieved (see section 5.C.1).</li> <li>Check that the area under the foot control pedal is clean and free of all obstructions.</li> </ul>
<p>Puller is not achieving maximum pulling force or speed.</p>	<ul style="list-style-type: none"> <li>Check adjustable pressure relief valve setting to ensure that it is not opening prematurely (see section 11.B).</li> <li>Check the hydraulic power source that the hydraulic power provided to the puller is the required 2000 to 2500 psi (137-172 bar) of pressure and 6 to 10 gpm (22.7-37.9 lpm) of flow.</li> <li>Check system for hydraulic leaks.</li> </ul>
<p>Pull line will not stay on the capstan.</p>	<ul style="list-style-type: none"> <li>Puller is not properly aligned with the pull line. The pull line must be placed around the capstan at a slight angle to the edge of the capstan (see section 7.A).</li> </ul>
<p>Capstan will not go onto the puller shaft.</p>	<ul style="list-style-type: none"> <li>The posts on the shaft must line up with the grooves on the capstan (see section 5.D).</li> <li>Apply an anti-seize compound to the ID of the capstan and the OD of the puller shaft.</li> </ul>
<p>Hydraulic quick-connect couplings will not go together.</p>	<ul style="list-style-type: none"> <li>Hydraulic pressure is remaining in the hydraulic lines. Carefully unscrew one of the quick-connect couplings to relieve the internal pressure. Before disconnecting the hoses, be sure to cycle the foot control valve with the power supply off to relieve any internal pressures.</li> <li>Contamination has gotten into the couplings. Visually inspect couplings; clean and remove any contamination. Use the supplied dust caps.</li> </ul>



## B. ELECTRONIC CONTROL BOX

PROBLEM:	SOLUTION:
Digital display is not functioning.	<ul style="list-style-type: none"> <li>• Turn electronic control box power switch <b>ON</b> (see section 6.C.1).</li> <li>• Check 12 Volt DC power supply (see section 6.B.3).</li> <li>• Check all electrical connections.</li> </ul>
Digital display does not display expected values.	<ul style="list-style-type: none"> <li>• Capstan size is different from capstan selected on electronic control box (see section 6.C.2).</li> </ul>
Numbers on digital display start counting up and do not stop with no load on the capstan.	<ul style="list-style-type: none"> <li>• Load cell is not properly connected to the electronic control box. Verify all connections are made and are tight (see section 6.B.1)</li> </ul>
Capstan does not stop rotating when programmed tension limit is reached.	<ul style="list-style-type: none"> <li>• TENSION LIMIT CONTROL is <b>OFF</b>.</li> <li>• Tension limit is not set to desired load. Press the “Prog” Button and ▼ button simultaneously. Press the ▲ and ▼ buttons to increase or decrease the tension limit. Press “Prog” to save the set point. (see section 6.C.3).</li> <li>• Footswitch is not properly connected to the electronic control box. Verify all connections are made and are tight. (see section 6.B.2).</li> </ul>
Capstan stops rotating before line tension reaches preset load limit programmed into electronic tension controller.	<ul style="list-style-type: none"> <li>• Adjustable pressure relief valve is set lower than programmed tension limit. Increase adjustable relief valve setting (see section 11.B).</li> <li>• Tension limit is not set to desired load. Press the “Prog” Button and ▼ button simultaneously. Press the ▲ and ▼ buttons to increase or decrease the tension limit. Press “Prog” to save the set point. (see section 6.C.3).</li> </ul>
Chart recorder is not functioning.	<ul style="list-style-type: none"> <li>• Check to see that the card is firmly inserted in the slot.</li> <li>• Verify that the chart recorder’s Record Mode has been switch to <b>ON</b>. Red LED light is lit.</li> </ul>

### C. FOOT CONTROL VALVE

<b>PROBLEM:</b>	<b>SOLUTION:</b>
Foot control pedal is sticking, will not return to neutral.	<ul style="list-style-type: none"><li>• Remove item numbers 33, 32, 31, 30, knob steel, knob flow adjustment, body spool stop upper &amp; body spool stop lower.</li><li>• Remove capscrew, spring &amp; washer assembly.</li><li>• Confirm washer are flat, clean and lubricate the capscrew, spring and washer assembly.</li><li>• Re-assemble capscrew, spring and washer assembly to the foot control assembly.</li><li>• Re-assemble body spool lower.</li><li>• Try foot control, if it works re-assemble body spool upper, knob steel and flow adjustment.</li><li>• If foot control still sticks, loosen capscrew without removing body spool lower, move foot control up and down full stroke, tighten capscrew and assemble body spool upper, knob steel and knob flow adjustment.</li></ul>

### D. ROUTINE MAINTENANCE/CLEANING SCHEDULE

#### 1. After Every Pull

- Inspect all fasteners and locking pins to insure they are not loose or damaged.
- Inspect puller fram for deformation or material to insure the prame was not overloaded.

#### 2. Once a Week

- Check hydraulic components for leaks or damage.

#### 3. Once a Month

- Check all hydraulic hoses and control unit for damage or sticky valves.

# Replacement Parts & Accessories

## 13.

<b>Replacement / Repair Part</b>	<b>Part Number</b>
User's Guide & Safety Manual	08675881
User's Video	08675196
Warning Label Kit	08675333
Hydraulic Hose Kit, Power Supply to Foot Control Valve	08675858
Hydraulic Hose Kit, Puller to Foot Control Valve	08675322
Foot Control Valve Assembly	08675857
Shipping Crate	02264500
<b>Upgrade Packages **</b>	
Package 1 to Package 3 Upgrade	08675920
<b>Fiber Optic Cable Puller Accessories</b>	
Dillion 1,000 lb (4,400 N) Calibration Dynamometer	02261000
Portable Hydraulic Power Pack, Gas	08675200
Capstan, 12 inch (305 mm) diameter <sup>2</sup>	08675213
Capstan, 30 inch (762 mm) diameter - 4" wide (102 mm)	08675230
Capstan, 30 inch (762 mm) diameter - 8" wide (203 mm)	08675430
Capstan, 42 inch (1,067mm) diameter	08675436
Capstan, 50 inch (1,270 mm) diameter	08675220
Remote Mounting Stand	08675115
Pole Mounting Frame	08676000
Hitch Mount	08675908
Base Mount Weldment <sup>3</sup>	08675130
Side Mount Weldment <sup>3</sup>	08675138
Floor Socket Mount, Cast <sup>3</sup>	02260801

\*\* See section 4.A for details on Package contents.

<sup>2</sup> Not to be used for fiber optic cable. Intended for pulling innerduct and power, telephone, or coaxial cables.

<sup>3</sup> See Appendix 13.A for details on the hydraulic supply hose kits and appendices 13.F and 13.G for details on the puller mounts.

Contact Condux Customer Service for other accessories that may have been added after the printing of this manual. Additional accessories may be available upon request.

# Warranty Information

# 14.

## A. FACTORY ASSISTANCE

Condux International can provide further advise regarding any problems with the installation, service, assembly, or disassembly of the Fiber Optic Cable Puller. Call toll free at 1-800-533-2077 (USA and Canada) or 1-507-387-6576 and ask for assistance. The Fiber Optic Cable Puller can be returned to the factory at any time for service or repair; however, obtain a Return Material Authorization (RMA) must be obtained from Condux before shipping. Condux will not accept returned items without an RMA.

## B. PULLER CALIBRATION

**NOTE:** Calibrate the Condux Fiber Optic Cable Puller regularly to ensure its accuracy. If the calibration procedures specified in section 11 are not possible at the operator's location, we recommend returning the Cable Puller to Condux International at least once a year for verification or calibration at the factory.

To return the Condux Fiber Optic Cable Puller to Condux International for verification or calibration, call Condux customer service for a Return Material Authorization (RMA). Ship the RMA form along with the puller assembly, foot control valve assembly, electronic control box and capstan to Condux International. We will calibrate and ship the Cable Puller back out within 48 hours of receipt. There is a nominal charge for this calibration.

## C. LIMITED WARRANTY

Condux International, Inc. extends the following warranty to the original purchaser of these goods for use, subject to the qualifications indicated:

Condux International, Incorporated warrants to the original purchaser for use that the goods or any component thereof manufactured by Condux International will be free from defects in workmanship for a period of one year from the date of purchase, provided such goods are installed, maintained, and used in accordance with Condux's written instructions.

Components not manufactured by Condux International but used within the assembly provided by Condux International are subject to the warranty period as specified by the individual manufacturer of said component, provided such goods are installed, maintained, and used in accordance with Condux's and the original manufacturer's written instructions.

Condux's sole liability and the purchaser's sole remedy for a failure of goods under this limited warranty, and for any and all claims arising out of the purchase and use of the goods, shall be limited to the repair or replacement of the goods that do not conform to this warranty.

To obtain repair or replacement service under the limited warranty, the purchaser must contact the factory for a Return Material Authorization (RMA). Once obtained, send the RMA along with the defective part or goods, transportation prepaid, to:

Condux International, Inc.  
145 Kingswood Drive  
Mankato, MN 56002 USA

**THERE ARE NO EXPRESS WARRANTIES COVERING THESE GOODS OTHER THAN AS SET FORTH ABOVE. THE IMPLIED WARRANTIES OF MERCHANTABILITY AND FITNESS FOR A PARTICULAR PURPOSE ARE LIMITED IN DURATION TO ONE YEAR FROM DATE OF PURCHASE.**

**CONDUX ASSUMES NO LIABILITY IN CONNECTION WITH THE INSTALLATION OR USE OF THIS PRODUCT, EXCEPT AS STATED IN THIS LIMITED WARRANTY. CONDUX WILL IN NO EVENT BE LIABLE FOR INCIDENTAL OR CONSEQUENTIAL DAMAGES.**



**ISO 9001:2008**  
CERTIFIED

**Condux International, Inc.**

---

P.O. Box 247 • 145 Kingswood Drive, Mankato, MN 56002-0247 USA

1-507-387-6576 • 1-800-533-2077 • FAX 1-507-387-1442

Internet: <http://www.condux.com> • E-mail: [cndxinfo@condux.com](mailto:cndxinfo@condux.com)

© Copyright 2009, Condux International, Inc.

Printed in USA

Literature Part Number: 08675881

Revision Number: 2.7